

Haiwell PLC User Manual

Classic Programmable Logic Controller

Analog Module User Manual & Application Case

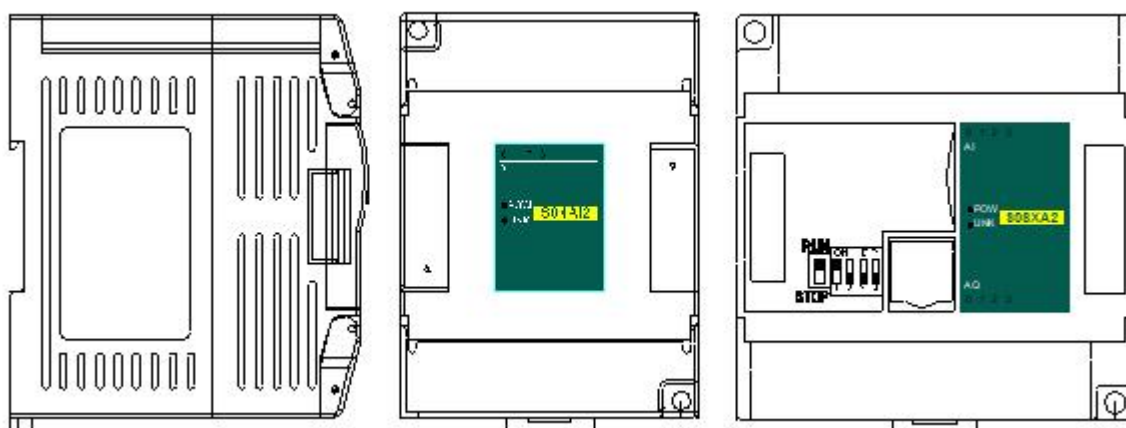

Contents

Analog Module User Manual

1. Product Model List and Dimension	3
2. Indicator Description	3
3. Power Supply Specification	4
4. Environmental Specifications for Product	4
5. Analog Input (AI) Specification	4
6. Analog Output (AQ) Specification	4
7. Analog Input (AI) Wiring Diagram	4
8. Analog Output (AQ) Wiring Diagram	5
9. MPU Terminal Wiring Diagram	5
10. Module Parameter Table (CR code is corresponding to the Modbus register address)	6
4-channel analog module parameter table	6
8-channel analog module parameter table	7
11. Mounting and installation	8

Analog Module Application Case

1. Expand module through the host PLC parallel port	9
1.1. Module power supply	9
1.2. The analog need't be written any conversion program, read the analog register value directly.	9
1.3. Programming skills	10
1.4. Display analog value on SCADA, HMI	10
1.5. When the engineering value is not used, the default code value is 0 ~ 32000	10
1.6. Module CR code application example: Read the module channel disconnection alarm	11
2. Module used as remote IO	11
2.1. Module power supply	11
2.2. Communication port introduction	12
2.3. Communication protocols and default parameters	12
2.4. Module parameter configuration method introduction, when the module is used as remote IO	12
2.5. Parameter configuration example: The module is configured by programming software remote module tool	12
Hardware connection	12
Software operation steps	13
2.6. Remote IO application example(RS485 mode): The PLC read the 4 communication temperature values of S04AI module	14
2.7. Remote IO application example (RS485 mode): The PLC writes the 8-channel output values of S08AO module	15
2.8. Remote IO application example(Ethernet mode): PLC read and write each channel input and output values of S08XA-e15	
2.9. Haiwell Cloud configuration communicates directly with S08AI module example	16

Analog Module User Manual

1. Product Model List and Dimension

Ethernet Model	24VDC	Ethernet Model	220VAC	Model	24VDC	Model	220VAC	Dimension
				S04AI	0.07A	S04AI2	7W	70×95×82mm
				S04AO	0.15A	S04AO2	8.8W	
				S04XA	0.1A	S04XA2	7.8W	
S08AI-e	0.11A	S08AI2-e	7.9W	S08AI	0.08A	S08AI2	7.3W	93×95×82mm
S08AO-e	0.25A	S08AO2-e	12.4W	S08AO	0.22A	S08AO2	11.8W	
S08XA-e	0.18A	S08XA2-e	10.4W	S08XA	0.15A	S08XA2	9.8W	

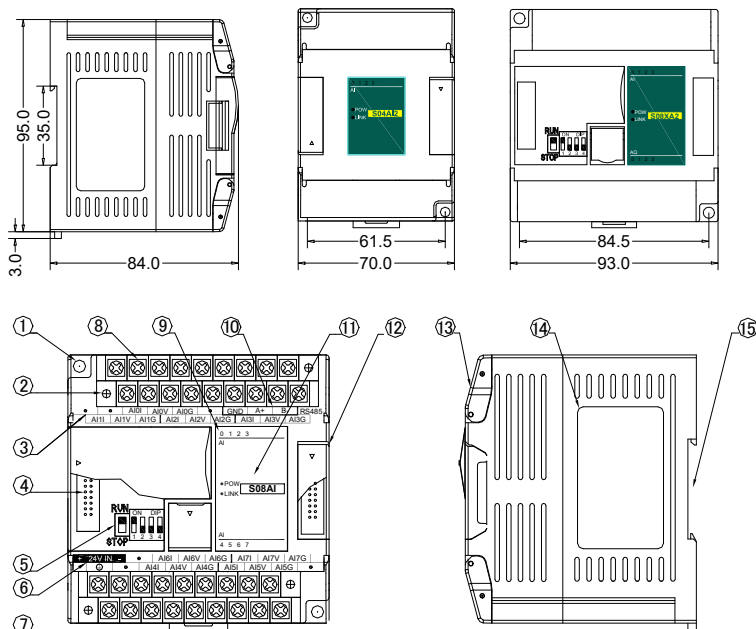

1. Fixed hole	8. Removable terminal
2. Removable terminal screw	9. Analog input channel indicator
3. Terminal definition	10. RS485 communication port
4. Module expansion port	11. PWR power indicator, LINK module communication indicator
5. DIP switch (4-channel module without DIP switch)	12. Module expansion port
6. External power supply terminal (DC24V and AC220V, Generally powered by the host PLC)	13. Transparent cover of module terminal
7. Guide rail buckle	14. Module nameplate
	15. 35mm DIN guide rail

2. Indicator Description

- ① **PWR**: power indicator. green, constant light -Power normal; Not light - Power abnormal.
- ② **LINK**: multi-status indicator . three colors (Red. Yellow. Green), as follow:

Reference processing mode	Module bus state	LINK indicator state
Normal	No communication of module	No light
	MPU has identified the module but no communication	Constant light in green
	Serial or parallel port in communication	Green jitter: indicator on 30ms and off 30ms
Parallel power supply not enough, must connect to external power supply	Without serial or parallel port in communication	Yellow flicker: indicator on 0.5s and off 0.5s
	With serial or parallel port in communication	Yellow is darkened and jitter alternately: indicator off 0.5s and jitter 0.5s
Firmware upgrade failed, reupgrade the module firmware	Without serial or parallel port in communication	Red flicker: indicator on 0.5s and off 0.5s
	With serial or parallel port in communication	Red is darkened and jitter alternately: indicator off 0.5s and jitter 0.5s
Hardware failure and maintenance	Without serial or parallel port in communication	Constant light in red
	With serial or parallel port in communication	Red jitter quickly: indicator on 30ms and off 30ms

- ③ **RJ45 Ethernet indicator**: there are two Ethernet LEDs, green and yellow, as shown on the picture:

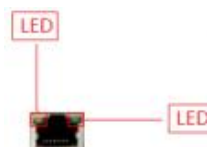

Color	Status description
Green light is long bright	Physical connection of TCP module and external device is normal;
Green light goes out	TCP module fails to connect with external device or the module itself is abnormal
Yellow light blinks	TCP module is connected to an external device normally, and blinking frequency indicates the data transmission speed. When speed is fast, human eye is not easy to distinguish, at this time, yellow light is long bright.
Yellow light goes out	No data transmission communication of TCP module and external device

3. Power Supply Specification

Item	DC Power Supply	AC Power Supply
Power supply voltage	24VDC -15%~+20%	100~240VAC
Power supply frequency	—	50~60Hz
Instantaneous surge	MAX 20A 1.5ms @24VDC	20A 1.5ms MAX @220VAC
Power loss time	10ms or less	20ms or less @220VAC
Fuse	0.3A, 250V	2A, 250V
24V Output voltage (for input and expansion)	None	24V, -15%~+15%, 200mA (Max)
Isolation Type	No Electrical isolation	Transformer isolation or optoelectronic isolation, 1500VAC/1 minute
Power Protection	DC input power polarity reverse, over voltage protection	DC 24V output over current protection

4. Environmental Specifications for Product

Item	Environment Specification
Temperature/Humidity	Operating temperature:0~+55℃ Storage temperature:-25~+70℃ Humidity: 5~95%RH, No condensation
Vibration Resistance	10~57 HZ, amplitude=0.075mm, 57HZ~150HZ acceleration=1G, 10 times each for X-axis, Y-axis and Z-axis
Impact Resistance	15G, duration=11ms, 6 times each for X-axis, Y-axis and Z-axis
Interference Immunity	DC EFT:±2500V Surge:±1000V
Over Voltage Resistance	1500VAC/1min between AC terminal and PE terminal, 500VAC/1min between DC terminal and PE terminal
Insulation Impedance	Between AC terminal and PE terminal @500VDC, >=5MΩ, all input/output points to PE terminal @500VDC
Operating environment	Avoid dust, moisture, corrosion, electric shock and external shocks

5. Analog Input (AI) Specification

Properties	Voltage input			Current input	
Input range	0V~+10V	0V~+5V	1V~+5V	0~20mA	4~20mA
Max. allowed input	13V			30mA	
Range of digital value	0-32000	0-32000	0-32000	0-32000	0-32000
Input impedance	6MΩ			250Ω	
Response time	2.0ms/ch				
Resolution	16 bits				
Basic error	Room temperature 25±5℃	±0.20%			
	Full temperature range	±0.5%			
Linearity error	Room temperature 25±5℃	±0.10%			
	Full temperature range	±0.10%			
Status display	If the channel is normal, the indicator light will be on.				
Diagnostics function	If disconnection or limit-exceeding (≥110%FS) is detected, the indicator light will be off.				
Isolation	Isolation between an analog circuit and a digital circuit No isolation between channels				
Power supply	24VDC ±20%, 200mA (Max.)				
Notices: 1. If the input signal exceeds the input range, the digital value will be 32000. 2. If the input signal exceeds the maximum allowed voltage or current, the channel might be damaged. 3. It is not allowed to connect the wire inversely.					

6. Analog Output (AQ) Specification

Properties	Voltage output			Current output	
Output range	0V~ +10V	0V~+5V	1V~+5V	0~20mA	4~20mA
Range of digital value	0-32000	0-32000	0-32000	0-32000	0-32000
Load impedance	1KΩ@10V	≥500Ω@ 10V		≤500Ω	
Response time	3.0ms/ch				
Resolution	12 bits				

Properties		Voltage output	Current output
Basic error	Room temperature 25±5℃	±0.30 %	
	Full temperature range	±0.60 %	
Linearity error	Room temperature 25±5℃	±0.20 %	
	Full temperature range	±0.20 %	
Status display		If the channel is normal, the indicator light will be on.	
Isolation		Isolation between an analog circuit and a digital circuit No isolation between channels	
Power supply		24VDC ±20%, 200mA (Max.)	
Notices: 1. If the load doesn't meet the requirement, the accuracy of output might be effected. 2. If there is short-circuit or voltage backflow, the channel might be damaged.			

7. Analog Input (AI) Wiring Diagram

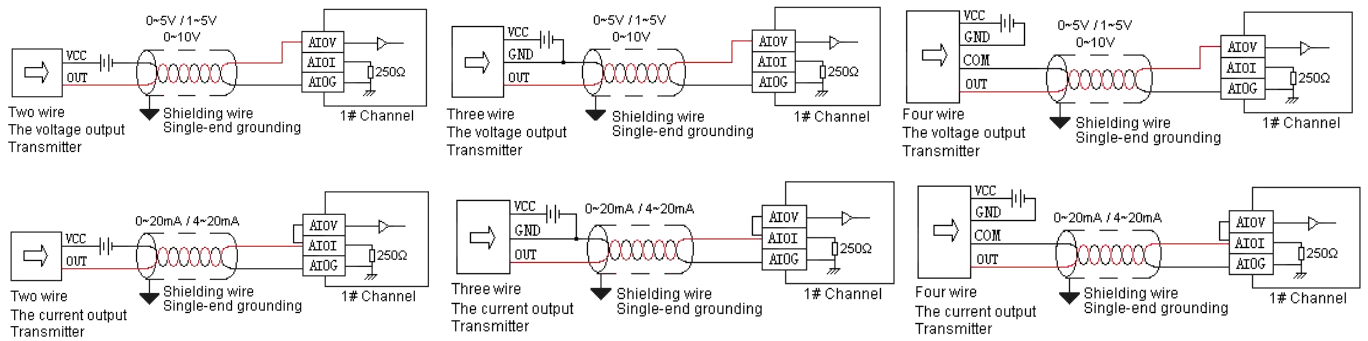

8. Analog Output (AQ) Wiring Diagram

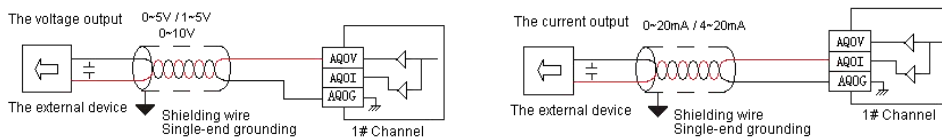

9. MPU Terminal Wiring Diagram

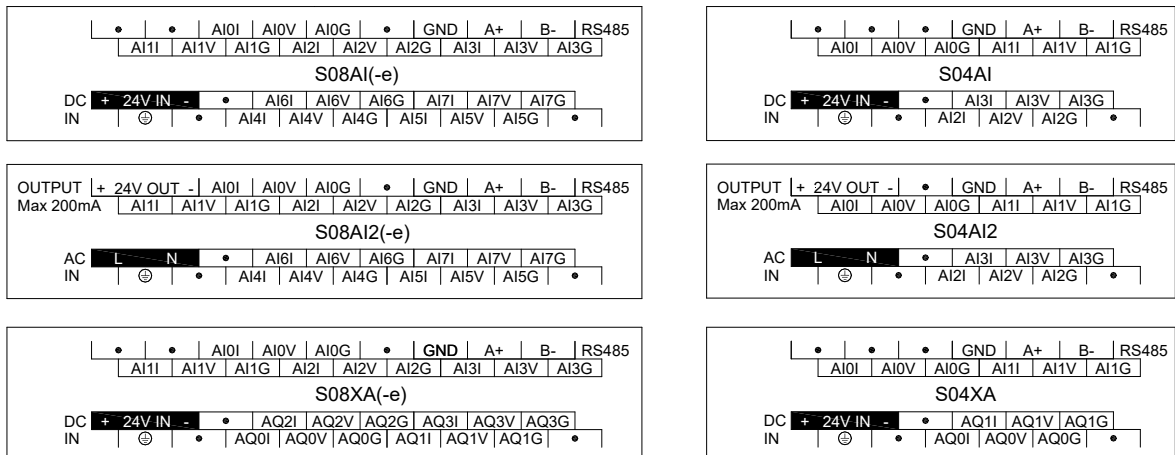

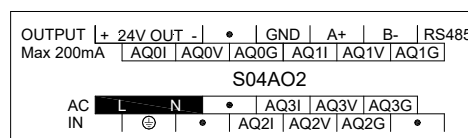
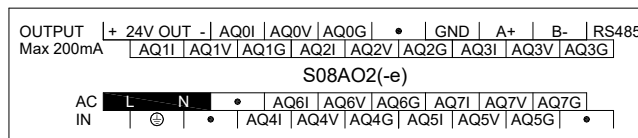
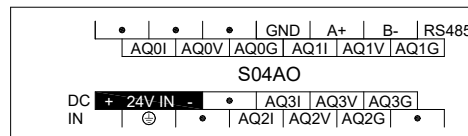
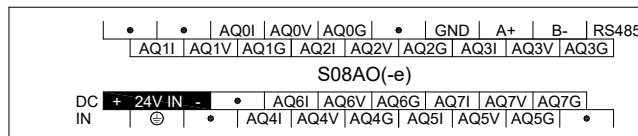
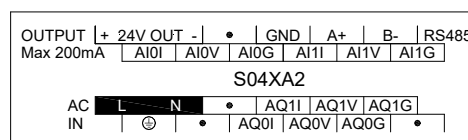
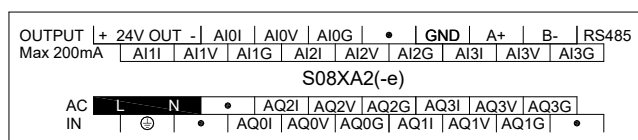

10. Module Parameter Table (CR code is corresponding to the Modbus register address)

4-channel analog module parameter table

Note: CR code is corresponding to the Modbus register address, the ray parts are read-only ,the white parts are readable and writable.

CR code	Function description		
	S04AI	S04AO	S04XA
00H	Low byte for module code, and high byte for module version number.		
01H	Communication address		
02H	Communication protocol: The low 4-bit of the low byte: 0 - N,8,2 For RTU, 1 - E,8,1 For RTU, 2 - O,8,1 For RTU, 3 - N,7,2 For ASCII, 4 - E,7,1 For ASCII, 5 - O,7,1 For ASCII, 6 - N,8, 1 For RTU The high 4-bit of the low byte: 0 - 2400, 1 - 4800, 2 - 9600, 3 - 19200, 4 - 38400, 5 - 57600, 6 - 115200		
03H~06H	Module name		
07H~08H	Default IP address: 192.168.1.111		
09~0AH	Reserve		
0BH	High byte subnet mask (b3~b0,1 indicates 255, 0 indicates 0, for example subnet mask 255.255.255.0, b3~b0=1110), low byte reserved		
0CH~0EH	Reserve		
0FH	Error code: 0-Normal, 1-Illegal firmware identity, 2-Incomplete firmware, 3-System data access exception, 4-No external 24V power supply		
10H	channel 1 input value	channel 1 output value	input channel 1 input value
11H	channel 2 input value	channel 2 output value	input channel 2 input value
12H	channel 3 input value	channel 3 output value	input channel 1 signal type, note 2
13H	channel 4 input value	channel 4 output value	input channel 2 signal type, note 2
14H	channel 1 signal type, note 2	channel 1 signal type, note 2	Use the engineering value mark, note 6
15H	channel 2 signal type, note 2	channel 2 signal type, note 2	input channel 1 engineering lower limiting value
16H	channel 3 signal type, note 2	channel 3 signal type, note 2	input channel 2 engineering lower limiting value
17H	channel 4 signal type, note 2	channel 4 signal type, note 2	input channel 1 engineering upper limiting value
18H	Use the engineering value mark, note 6	Use the engineering value mark, note 6	input channel 2 engineering upper limiting value
19H	channel 1 engineering lower limiting value	channel 1 engineering lower limiting value	input channel 1 sampling frequency, note 1
1AH	channel 2 engineering lower limiting value	channel 2 engineering lower limiting value	input channel 2 sampling frequency, note 1
1BH	channel 3 engineering lower limiting value	channel 3 engineering lower limiting value	input channel 1 zero point correction value
1CH	channel 4 engineering lower limiting value	channel 4 engineering lower limiting value	input channel 2 zero point correction value
1DH	channel 1 engineering upper limiting value	channel 1 engineering upper limiting value	Channel 1~2 input disconnection alarm, note 5
1EH	channel 2 engineering upper limiting value	channel 2 engineering upper limiting value	output channel 1 output value
1FH	channel 3 engineering upper limiting value	channel 3 engineering upper limiting value	output channel 2 output value
20H	channel 4 engineering upper limiting value	channel 4 engineering upper limiting value	output channel 1 signal type, note 2
21H	channel 1 sampling frequency, note 1	power-off output mark, note 8	output channel 2 signal type, note 2
22H	channel 2 sampling frequency, note 1	channel 1 power-off output value	Use the engineering value mark, note 6
23H	channel 3 sampling frequency, note 1	channel 2 power-off output value	output channel 1 engineering lower limiting value
24H	Channel 4 sampling frequency, note 1	channel 3 power-off output value	output channel 2 engineering lower limiting value
25H	channel 1 zero point correction value	channel 4 power-off output value	output channel 1 engineering upper limiting value
26H	channel 2 zero point correction value	Channel indicator status, note 7	output channel 2 engineering upper limiting value
27H	channel 3 zero point correction value	Reserve	power-off output mark, note 8
28H	channel 4 zero point correction value		output channel 1 power-off output value
29H	Channel 1~4 input disconnection alarm, note 5		output channel 2 power-off output value

CR code	Function description		
	S04AI	S04AO	S04XA
2AH	Reserve		output channel indicator, note 7
2BH~2FH			Reserve

8-channel analog module parameter table

Note: CR code is corresponding to the Modbus register address, the gray parts are read-only, the white parts are readable and writable.

CR code	Function description		
	S08AI	S08AO	S08XA
00H	Low byte for module code, and high byte for module version number.		
01H	Communication address		
02H	Communication protocol: The low 4-bit of the low byte: 0 - N,8,2 For RTU, 1 - E,8,1 For RTU, 2 - O,8,1 For RTU, 3 - N,7,2 For ASCII, 4 - E,7,1 For ASCII, 5 - O,7,1 For ASCII, 6 - N,8, 1 For RTU The high 4-bit of the low bytes: 0 - 2400, 1 - 4800, 2 - 9600, 3 - 19200, 4 - 38400, 5 - 57600, 6 - 115200		
03H~06H	Module name		
07H~08H	Default IP address: 192.168.1.111		
09~0AH	Reserve		
0BH	High byte subnet mask(b3~b0,1 indicates 255,0 indicates 0 , for example, subnet mask 255.255.255.0, b3~b0=1110), low byte Reserved		
0CH~0EH	Reserve		
0FH	Error code: 0-Normal, 1-Illegally firmware identity, 2-Incomplete firmware, 3-System data access exception, 4-No external 24V power supply		
10H	channel 1 input value	channel 1 output value	input channel 1 input value
11H	channel 2 input value	channel 2 output value	input channel 2 input value
12H	channel 3 input value	channel 3 output value	input channel 3 input value
13H	channel 4 input value	channel 4 output value	input channel 4 input value
14H	channel 5 input value	channel 5 output value	input channel 1 signal type, note 2
15H	channel 6 input value	channel 6 output value	input channel 2 signal type, note 2
16H	channel 7 input value	channel 7 output value	input channel 3 signal type, note 2
17H	channel 8 input value	channel 8 output value	input channel 4 signal type, note 2
18H	channel 1 signal type, note 2	channel 1 signal type, note 2	Use the engineering value mark, note 6
19H	channel 2 signal type, note 2	channel 2 signal type, note 2	input channel 1 engineering lower limiting value
1AH	channel 3 signal type, note 2	channel 3 signal type, note 2	input channel 2 engineering lower limiting value
1BH	channel 4 signal type, note 2	channel 4 signal type, note 2	input channel 3 engineering lower limiting value
1CH	channel 5 signal type, note 2	channel 5 signal type, note 2	input channel 4 engineering lower limiting value
1DH	channel 6 signal type, note 2	channel 6 signal type, note 2	input channel 1 engineering upper limiting value
1EH	channel 7 signal type, note 2	channel 7 signal type, note 2	input channel 2 engineering upper limiting value
1FH	channel 8 signal type, note 2	channel 8 signal type, note 2	input channel 3 engineering upper limiting value
20H	Use the engineering value mark, note 6	Use the engineering value mark, note 6	input channel 4 engineering upper limiting value
21H	channel 1 engineering lower limiting value	channel 1 engineering lower limiting value	input channel 1 sampling frequency, note 1
22H	channel 2 engineering lower limiting value	channel 2 engineering lower limiting value	input channel 2 sampling frequency, note 1
23H	channel 3 engineering lower limiting value	channel 3 engineering lower limiting value	input channel 3 sampling frequency, note 1
24H	channel 4 engineering lower limiting value	channel 4 engineering lower limiting value	input channel 4 sampling frequency, note 1
25H	channel 5 engineering lower limiting value	channel 5 engineering lower limiting value	input channel 1 zero point correction value
26H	channel 6 engineering lower limiting value	channel 6 engineering lower limiting value	input channel 2 zero point correction value
27H	channel 7 engineering lower limiting value	channel 7 engineering lower limiting value	input channel 3 zero point correction value
28H	channel 8 engineering lower limiting value	channel 8 engineering lower limiting value	input channel 4 zero point correction value
29H	channel 1 engineering upper limiting value	channel 1 engineering upper limiting value	Channel 1~4 input disconnection alarm, note 5
2AH	channel 2 engineering upper limiting value	channel 2 engineering upper limiting value	output channel 1 output value
2BH	channel 3 engineering upper limiting value	channel 3 engineering upper limiting value	output channel 2 output value
2CH	channel 4 engineering upper limiting value	channel 4 engineering upper limiting value	output channel 3 output value
2DH	channel 5 engineering upper limiting value	channel 5 engineering upper limiting value	output channel 4 output value
2EH	channel 6 engineering upper limiting value	channel 6 engineering upper limiting value	output channel 1 signal type, note 2
2FH	channel 7 engineering upper limiting value	channel 7 engineering upper limiting value	output channel 2 signal type, note 2
30H	channel 8 engineering upper limiting value	channel 8 engineering upper limiting value	output channel 3 signal type, note 2
31H	channel 1 sampling frequency, note 1	power-off output mark, note 8	output channel 4 signal type, note 2
32H	channel 2 sampling frequency, note 1	channel 1 power-off output value	Use the engineering value mark, note 6
33H	channel 3 sampling frequency, note 1	channel 2 power-off output value	output channel 1 engineering lower limiting value
34H	channel 4 sampling frequency, note 1	channel 3 power-off output value	output channel 2 engineering lower limiting value
35H	channel 5 sampling frequency, note 1	channel 4 power-off output value	output channel 3 engineering lower limiting value

CR code	Function description		
	S08AI	S08AO	S08XA
36H	channel 6 sampling frequency, note 1	channel 5 power-off output value	output channel 4 engineering lower limiting value
37H	channel 7 sampling frequency, note 1	channel 6 power-off output value	output channel 1 engineering upper limiting value
38H	channel 8 sampling frequency, note 1	channel 7 power-off output value	output channel 2 engineering upper limiting value
39H	channel 1 zero point correction value	channel 8 power-off output value	output channel 3 engineering upper limiting value
3AH	channel 2 zero point correction value	Channel indicator status, note 7	output channel 4 engineering upper limiting value
3BH	channel 3 zero point correction value	Reserve	power-off output mark, note 8
3CH	channel 4 zero point correction value		output channel 1 power-off output value
3DH	channel 5 zero point correction value		output channel 2 power-off output value
3EH	channel 6 zero point correction value		output channel 3 power-off output value
3FH	channel 7 zero point correction value		output channel 4 power-off output value
40H	channel 8 zero point correction value		output channel indicator, note 7
41H	Channel 1~8 input disconnection alarm, note 5		Reserve
42H~4FH	Reserve		

Note:

1. Sampling frequency:0 - 2 times, 1 - 4 times, 2 - 8 times, 3 - 16 times, 4 - 32 times, 5 - 64 times, 6 - 128 times, 7 - 256 times
2. Signal type: 0 - [4,20]mA, 1 - [0,20]mA, 2 - [1,5]V, 3 - [0,5]V, 4 - [0,10]V
3. Disconnection alarm:Each bit indicates 1 channel, 0-normal, 1-disconnection
4. Use the engineering value mark:Each bit indicates 1 channel, 0-No, 1-Yes
5. Channel indicator status:Each bit indicates 1 channel, 0-off, 1-on
6. Power-off output mark:Each bit indicates 1 channel, 0-No, 1-Yes

11. Mounting and installation

The PLC should be secured to an enclosed cabinet while mounting. For heat dissipation, make sure to provide a minimum clearance of 50mm between the unit and all sides of the cabinet. (See the figure.)

Rail Mounting: Use standard 35 mm rail.

Screw Mounting: Each MPU or expansion module has two positioning screw holes, the diameter of the hole is 4.5mm. Please refer to the dimension figure for the location of the positioning holes and their spacing.

To avoid over temperature and for a better heat dissipation, do not mount PLC to a position near to the bottom/top of the cabinet. Do not mount PLC in vertical direction.

Expansion Module Wiring: Connections between expansion modules and connections between module and MPU are achieved through bus. One expansion cable will be configured to every expansion module, for the connection between two different modules. Connection methods: turn the right side of extended interface(the last MPU or expansion module) over, plug the expansion cable in the extended interface, then press down the cover of the extended interface to reset the interface, the extended interface at the right side of the module will be reserved for expansion of the next module. Connect all expansion modules in turn in the same way.

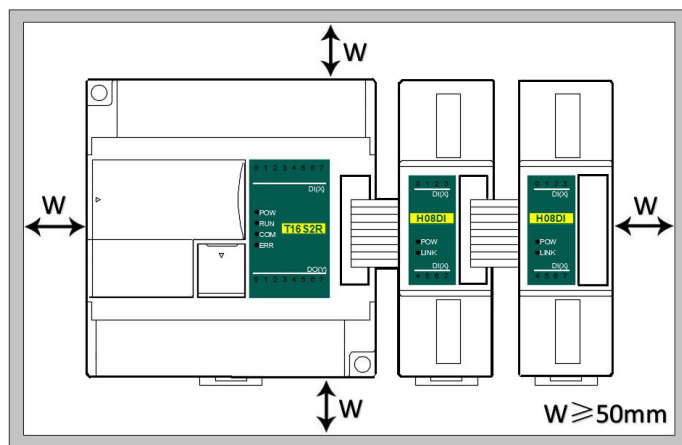

Analog Module Application Case

1. Expand module through the host PLC parallel port

1.1. Module power supply

Analog module can be the expansion module for any host PLC; When the module is directly hung behind the host PLC by parallel bus, no need to take external power supply, the module is powered by host PLC' parallel port, if the power supply of module is insufficient (the PWR power indicator does not light), then according to different models, the module can be powered by 24VDC or 220VAC. When the module is extended through the parallel port, it is recommended to use 24VDC module.

Module power supply example:

- ① When the host PLC can be expanded to 7 modules, the PWR indicators of first five modules are long bright, indicating the modules power supply are normal, and if the PWR indicators of the 6th and 7th modules are not light, appearing insufficient power supply, as long as the 6th and 7th modules are taken external power supply.
- ② When the host PLC with 1 expansion module, because the host PLC provides power supply through the parallel port, the PWR indicator of module will light; If the module is added external power supply, it can still work, this time the module will automatically determine and give priority to external power supply.

1.2. The analog need't be written any conversion program, read the analog register value directly.

For example, the host PLC T16S2T, respectively, is expanded with three modules of S04AI, S04AO and S08XA through the parallel port from left to right, assuming the scene:

- Analog module S04AI input channel 1, signal type is 4-20mA, used to measure the pressure, the pressure range of 0.0~3.0Mpa;
- Analog module S04AO input channel 1, signal type is 0-10V, used to control the inverter frequency of 0.0~50.0Hz;

First enter the PLC programming software menu bar - view - hardware configuration, in accordance with the external order of actual modules to add the module models, after added, the analog address will be automatically arranged, as shown below:

Module type	X Component	Y Component	AI Component	AQ Component	Other
T16S2T/P(-e)	X0 - X7	Y0 - Y7			COM1-2 HSC0-1 PLS0-1
S04AI			AI0 - AI3		
S04AO				AQ0 - AQ3	
S08XA			AI4 - AI7	AQ4 - AQ7	

Haiwell analog module need't be written any conversion program, as for above pressure measurement, we only need to check the use of engineering value, set the lower limit value of 0 corresponding 0.0Mpa, set the upper limit value of 3000 indicating 3.000Mpa, the upper limit value 3000 hidden three decimal places can achieve magnification times and improve accuracy.

Then we read the value of the analog input register AI0, if AI0 = 1234, then the actual value is 1.234Mpa.

Signal type	Use engineering units	Lower limit	Upper limit	Sample times
AI0 [4,20]mA	<input checked="" type="checkbox"/>	0	3000	64
AI1 [4,20]mA	<input type="checkbox"/>			64
AI2 [4,20]mA	<input type="checkbox"/>			64
AI3 [4,20]mA	<input type="checkbox"/>			64

Similarly, for the analog output, check the use of engineering value, set the lower limit value of 0 indicating 0.0Hz, set the upper limit value of 500 indicating 50.0Hz, if you want the inverter frequency output is 25.6Hz, as long as force the AQ0 value as 256 or through other logic instructions to output the AQ0 value of 256. As shown below:

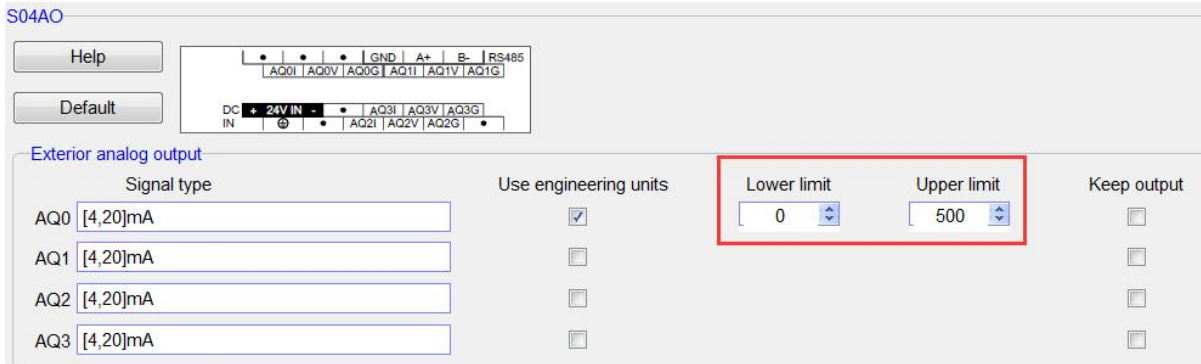

1.3. Programming skills

If you want to write the alarm program that pressure exceeds the setting value, for example, when the pressure is more than 1.25Mpa, it will alarm, the program of PLC can be written as follows:

```
//Network 1 When the liquid level is higher than the setting value 1.25Mpa, the alarm output
```

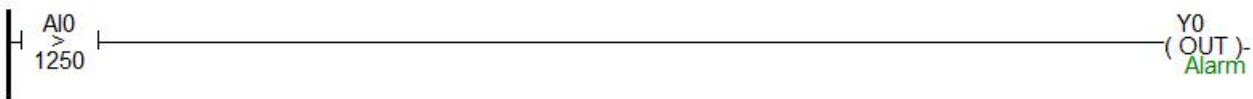

1.4. Display analog value on SCADA, HMI

If the configuration, touch screen, text and other PC software want to display the current pressure, only need to set three decimal places on the numerical display primitive, then the read value will be automatically reduced 1000 times in the configuration, that is the actual temperature value, for example, you can set 3 on decimal places of Haiwell Cloud SCADA settings.

So that when the PLC read AI0 value, AI0=1234, that is the actual value of 1.234Mpa, there is no need to have data processing in PLC and configuration, only set the 3 decimal places on the numerical display primitive, then it will be automatically reduced by 1000 times, displaying value of 1.234, that is the actual value of 1.234Mpa.

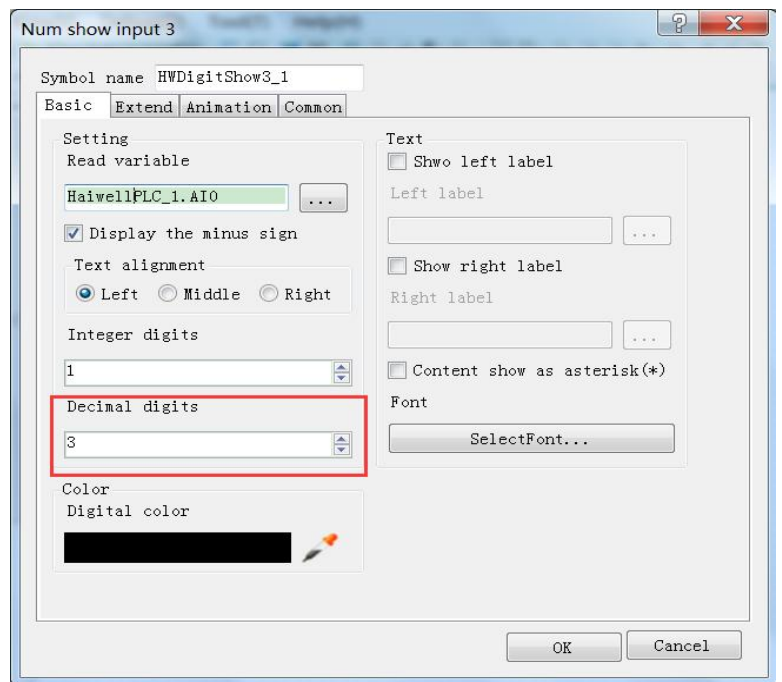

1.5. When the engineering value is not used, the default code value is 0 ~ 32000

When using the engineering value, the linear transformation is specified by the lower limit and the upper limit value, and the program is automatically transformed. When the engineering value is not used, all types are unified to correspond with 0 ~

32000 code value. The same case of pressure measurement, this time can according to the linear transformation formula: $Out = (In - InDw) * (OutUp - OutDw) / (InUp - InDw) + OutDw$ to write the conversion program, or use the SC linear transformation instructions to calculate directly.

Haiwell analog used easily, it is recommended to check the use of engineering value, so that the analog will be very convenient without writing any program.

1.6. Module CR code application example: Read the module channel disconnection alarm

In this example, in order to read the external sensor disconnection information of S08XA module, the disconnection alarm data of S08XA module input channel 1-4 is stored in CR29, that is, 29H (hexadecimal), decimal 41. (More CR contents can be found in the software online help - hardware manual - expansion module parameters within the corresponding model). This program is as follows:

- **Slot:** Position number, S08XA is the third module, so fill in 3;
- **CR:** Module disconnection alarm CR41, that is, 29H (hexadecimal) = 41 (decimal), it can be directly input 41 or 0x29 into the instruction CR terminal;
- **N:** Number for readings, 1 register for 16 bits, low 4 bits corresponding channel 1-4, disconnection for 1 (ON), normal for 0 (OFF).

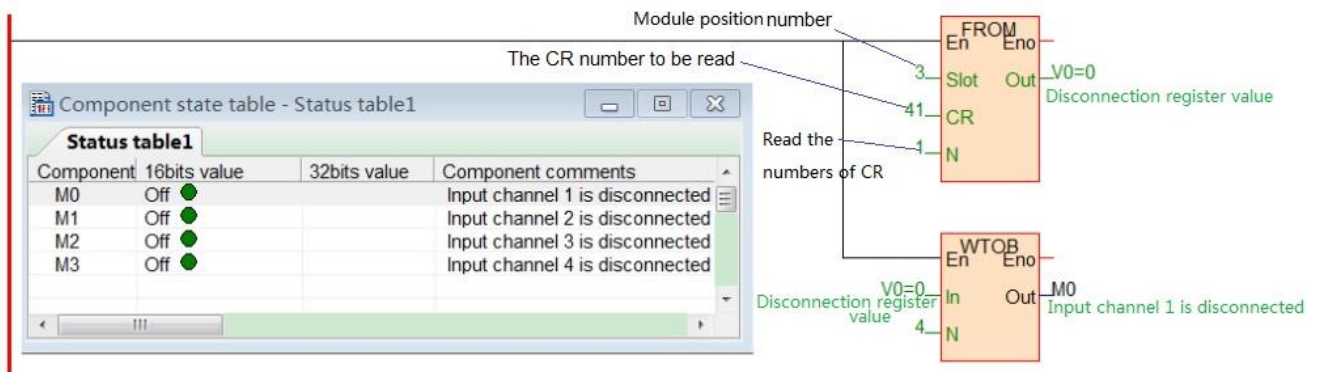

2. Module used as remote IO

Haiwell PLC expansion module is built-in one RS485 communication port (Some models with Ethernet communication port), which not only supports parallel bus (Use the expansion bus to connect with the parallel interface of host PLC), but also supports serial bus (Use the RS485 communication port of module networking with communication port of host PLC, and host PLC controls the remote module by communication instructions), when using the serial bus to expand (that is, remote IO module), it doesn't have expansion limit of system points and can be distributed installation.

Distributed installation is very important for the system which needs to collect and monitor a large number of decentralized digital or analog signals (temperature, humidity, differential pressure, blowing rate, flow, fan speed, valve opening, etc.), it can easily achieve distributed installation control and unlimited points of expansion, greatly improving the control system configuration flexibility and future control expansion capabilities, reducing the number of signal wiring, also reducing the interference problem of too long analog signal line, saving the project investment costs.

The following will introduce the operation key points and techniques.

2.1. Module power supply

When the module is used as remote IO, there are two optional models of 24VDC and 220VAC, such as S08AI model for the DC

24V power supply. S08AI2 for AC 220V power supply. If the module is powered normally, the PWR indicator will light.

2.2. Communication port introduction

- ① All analog modules are built-in RS485 port.
- ② As for 8-point analog module, you can choose the Ethernet port.
- ③ RS485 communication port and Ethernet port can be used at the same time, for example, the RS485 of module communicates with PLC, Ethernet port can also communicates with multiple host computers (up to 7).

2.3. Communication protocols and default parameters

RS485: Support standard Modbus RTU / ASCII protocol, it can communicate with the configuration, touch screen, text, PLC and other third-party host computer, which must support Modbus protocol. Among them:

- **Address:** 1 ~ 254 can be set; module address is divided into soft address and hard address, hard address has the highest priority.
- **Soft address:** The address set through programming software - remote tool, address range 1-254;
- **Hard address:** The address set through the 4-bit DIP switch of module hardware, address range 1-15. Hardware address setting example:

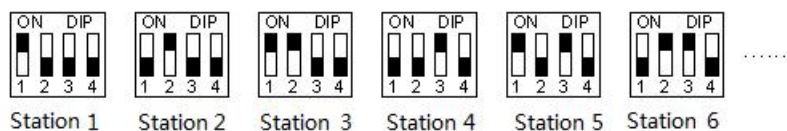

Baud rate: 2400, 4800, 9600, 19200, 38400, 57600, 115200 optional;

Data format: N, 8, 2 RTU, E, 8, 1 RTU, O, 8, 1 RTU, N, 8, 1 RTU, E, 7, 1 ASCII, O, 7, 1 ASCII, N, 7, 2 ASCII optional.

RS485 default parameter: 19200, N 8 2 RTU, station number is 1.

Ethernet +: Support the standard Modbus TCP protocol, it can communicate with the configuration, touch screen, PLC and other third-party host computers, which must support Modbus TCP protocol. Among them:

Ethernet default parameters:

IP: 192.168.1.111

Subnet mask: 255.255.255.0

Gateway: 192.168.1.1

2.4. Module parameter configuration method introduction, when the module is used as remote IO

There are three ways to configure remote IO parameters:

- ① It can be configured via programming software - tools - remote modules (recommended);
- ② It can be configured via the hardware configuration and TO instructions, when the module is hung behind the host PLC through the parallel port;
- ③ It can be configured via MODW instructions through the serial communication.

2.5. Parameter configuration example: The module is configured by programming software remote module tool

Hardware connection

- ① Through the RS485 communication port (the terminals of A +, B- on the module) connection: If the computer has a serial port, you can use the converter of 232 to 485 connecting with the module; if it has one USB interface, you can use the converter of USB to 485 connecting with the module.
- ② Through the connection of Ethernet + communication interface: You can connect the module with the computer's network port directly by the standard network cable, or take the computer and module connected to the switch.

Software operation steps

Click on the the menu bar tool of programming software- "remote module":

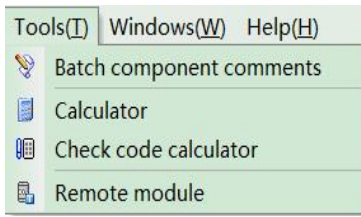

Click the button  in the pop-up window to open the "Online" window. The module default address is 1,19200, N 8 2 RTU, the online success is as follows:

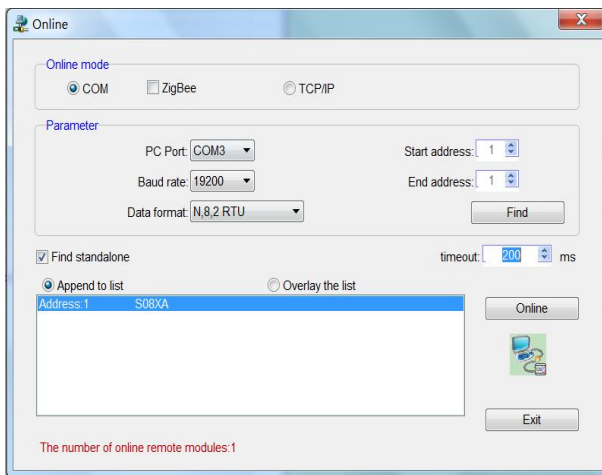

If there is only one machine connected with 485 line, then check "stand-alone search"; if there are more than one, then remove the button of "stand-alone search", and set the start address and end address, so that all the machines connected with 485 line can be found and achieve parameter configuration.

Click to exit, enter the configuration interface, as shown below:

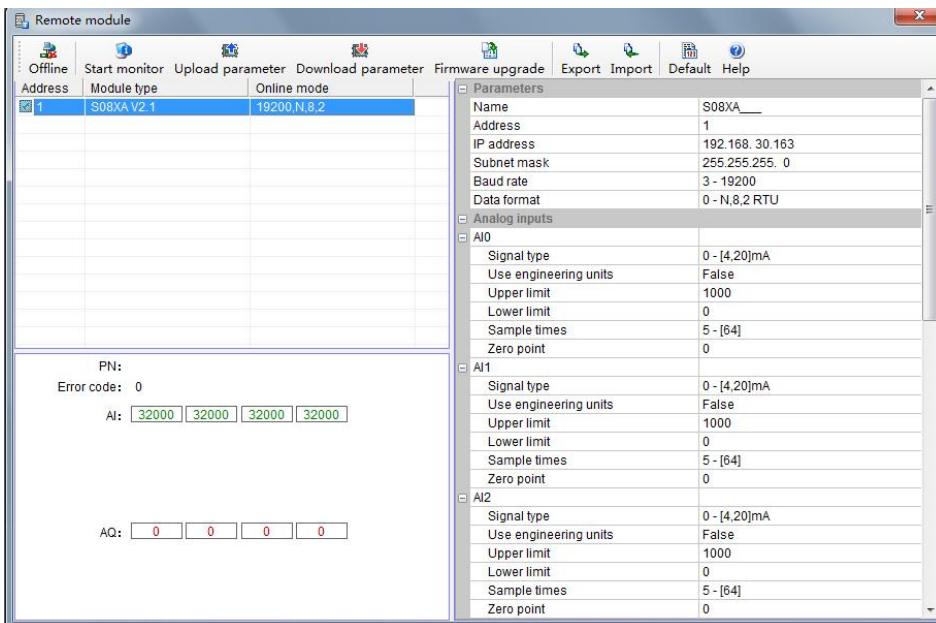

We can change the module name, address, IP, subnet mask, baud rate, data format and other communication parameters in the communication parameter area.

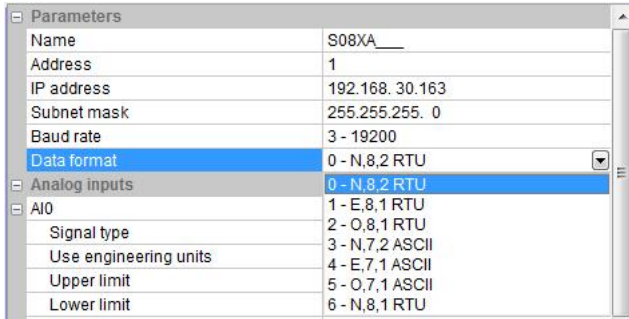

In the external analog input area, we can set the signal type of each channel, choose whether to use engineering value or not, the upper and lower limits of engineering value(it can be set if you check the use of engineering value), sampling times and zero correction.

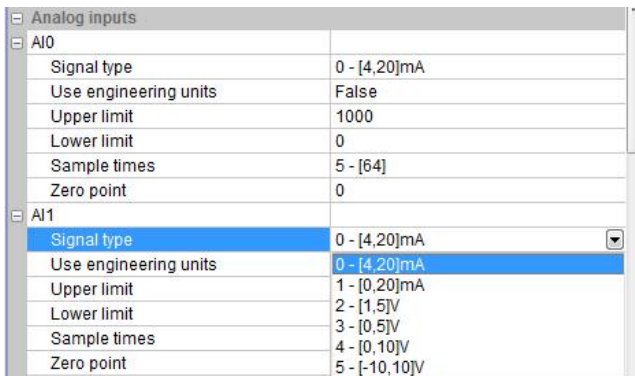

After setting, select the "parameter download" to download the parameter into the module.



In addition, we can do the following operations through the remote module tool:

- Online monitoring the channel value of module, error code.
- Upload the module parameter, upgrade the module firmware, then make the module support new features.
- It can export the module configuration to save or import and restore the default value.

2.6. Remote IO application example(RS485 mode): The PLC read the 4 communication temperature values of S04AI module

- ① Hardware wiring: PLC connects to 485 port of module by shielded twisted pair, A + connects to A +, B- connects to B-, if the PLC connects to multiple remote IO modules, it needs to use Hand in hand way to connect.
- ② Modbus address: From the above 4-channel analog CR parameter table shows that, the channel 1 ~ 4 input values are stored in 10H ~ 13H of S04AI module.
- ③ PLC program: Host PLC wants to read the 4-channel liquid level values of remote IO module S04AI, 0 ~ 1000 indicates that 0 ~ 1.0m. In this example, S04AI communication is the default parameter: Station number address is 1, baud rate is 19200, data format is N 8 2 RTU. The program of PLC reads the 4-channel liquid level values is as follows:

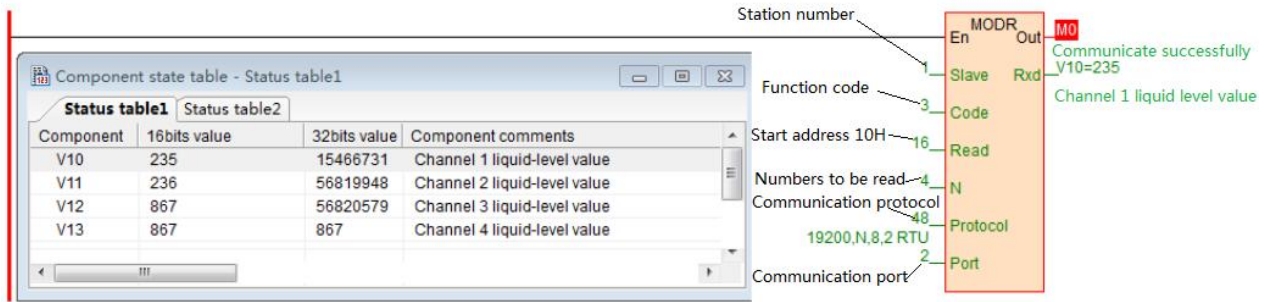

The host PLC reads the 4-channel liquid level values of S04AI by Modbus read instruction MODR, the start address is 10H (hexadecimal), that is, the decimal value is 16. When the communication is successful, M0 is ON, the liquid level values which are read back will be stored in V0-3, V0=235, indicating that the actual temperature of the first channel is 0.235m, the same as V3=867, indicating that the actual temperature of the fourth channel is 0.867m.

2.7. Remote IO application example (RS485 mode): The PLC writes the 8-channel output values of S08AO module

- ① Hardware wiring: PLC connects to 485 port of module by shielded twisted pair, A + connects to A +, B- connects to B-, if the PLC connects to multiple remote IO modules, it needs to use Hand in hand way to connect.
- ② Modbus address: From the above 8-channel analog CR parameter table shows that, the channel 1 ~ 8 output values of S08AO module are stored in address 10H~17H .
- ③ PLC program: Host PLC wants to write the 8-channel analog output values of remote IO module S08AO. In this example, S08AO communication parameters: Station number address is 2 (set by DIP switch), baud rate 19200, data format N 8 2 RTU. The program of writing 8-channel analog output values is as follows:

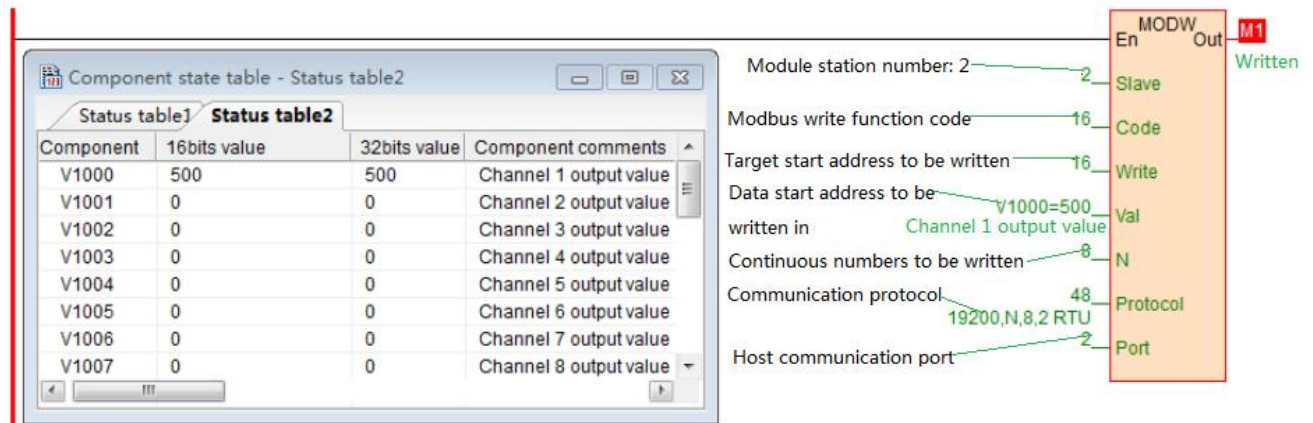

Host PLC writes the 8-channel analog output values of S08AO by Modbus write instruction MODW, the start address is 10H(hexadecimal), that is, the decimal value is 16. When writing successfully, M1 is ON, the 8-channel values which will be written into are stored in V1000-1007.

In this example, for the channel 1 of analog output, check the use of engineering value, the lower limit value is 0, the upper limit value is 3600, indicating that the valve opening is 0.0~360.0° , this case V1000=500, so the first output channel value is 500, that is, the valve opening is 50.0° .

2.8. Remote IO application example(Ethernet mode): PLC read and write each channel input and output values of S08XA-e

- ① Hardware wiring: PLC and module Ethernet port connected with a shielded network cable, they can be connected directly or through the switch.
- ② Modbus address: From the above S08XA-e analog module CR parameter table shows that the input values of module input channel 1 ~ 4 are stored in the address 10H ~ 13H. The output values of module output channel 1-4 are stored in

2AH ~ 2DH.

- ③ PLC program: Read the 4-channel measurements of remote Ethernet module S08XA-e and write the 4-channel output values of S08XA-e, if the module IP address is 192.168.1.112, station number address is 1, the read results are stored in the V0 ~ V3, the values to be written are stored in the register V10-V13. As follows:

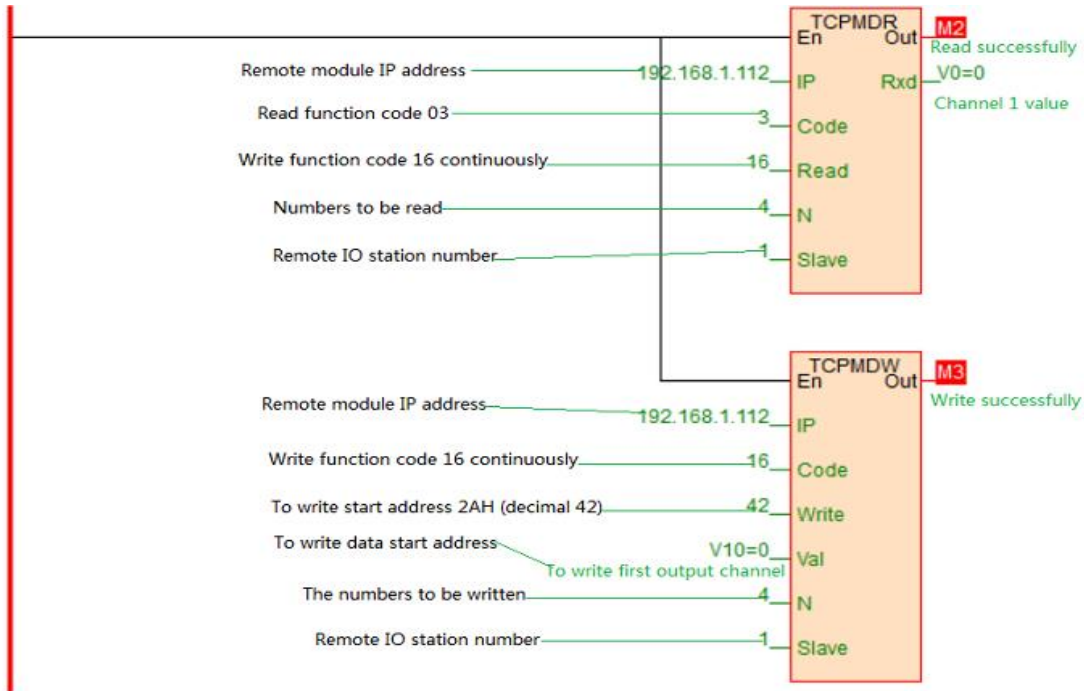

2.9. Haiwell Cloud configuration communicates directly with S08AI module example

Open Haiwell SCADA software, select the "new project", choose to add the device in the "device", then choose serial port or Ethernet according to the module which supports the Ethernet or RS485, this example for serial port, the serial port number of USB to 485 is COM6, as shown below:

Default parameter 19200 N 8 2 RTU for the module, station number address is 1. And directly select Haiwell remote module driver in serial port:

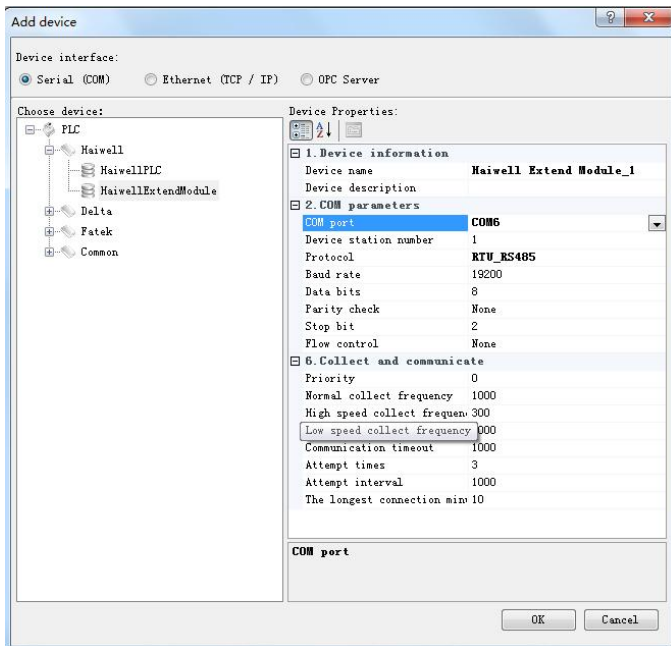

Click OK, then we are prompted to start set up variables, the establishment of eight variables indicates 8 channels:

Device properties Add Batch add Delete Online Off								
	Variable name	Register type	Register address	Address length	Data type	Read-write mode	Acquisition frequency	Variable description
▶ 1	CR16	CR	16	1	Integer	Read and write	Normal	
2	CR17	CR	17	1	Integer	Read and write	Normal	
3	CR18	CR	18	1	Integer	Read and write	Normal	
4	CR19	CR	19	1	Integer	Read and write	Normal	
5	CR20	CR	20	1	Integer	Read and write	Normal	
6	CR21	CR	21	1	Integer	Read and write	Normal	
7	CR22	CR	22	1	Integer	Read and write	Normal	
8	CR23	CR	23	1	Integer	Read and write	Normal	
*								

Then set up the screen, we can use the display primitives to bind the corresponding channel variable values. If you need to display the decimal places, it can set the corresponding decimal places on the display primitive. As shown below:

